



ASSEMBLY INSTRUCTION

speakON® STXX Series | NLT8MXX

Lockable 8 pole Loudspeaker Cable Connector with metal housing

IMPORTANT SAFETY INSTRUCTION

CAUTION: NOT FOR INTERRUPTING CURRENT
ATTENTION: NE PAS UTILISER POUR COUPER LE COURANT

Attention: speakON® is not to be used as an AC mains or power supply connector!

A

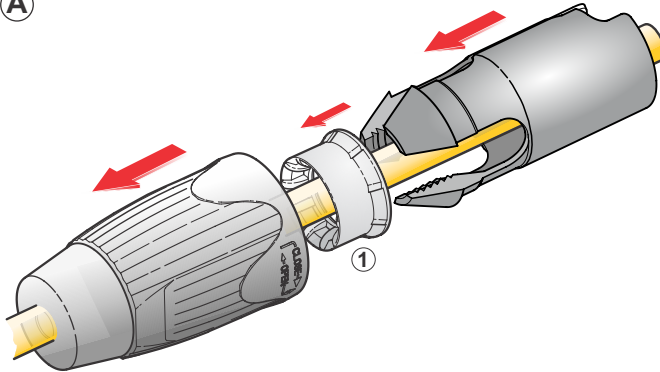

A Place bushing and chuck over the cable.

If cable O.D.:

Less 16 mm please use reducing piece (1).

B

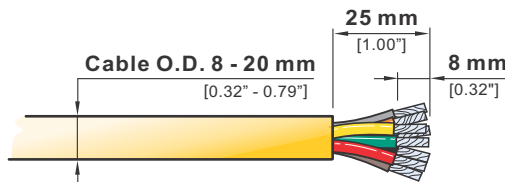

B Prepare cable as shown.

C Use 1/4" flat tabs or soldering to fix the wire ends to contacts of insert.

Wiring:

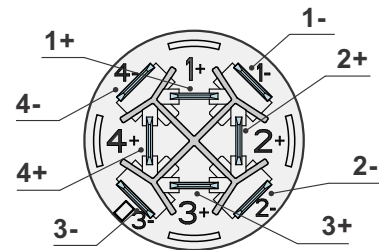

C

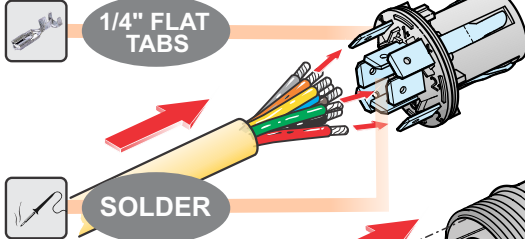

D Slide insert and chuck into housing.

Important: Align the insert by positioning the Neutrik to the top of the housing.

D

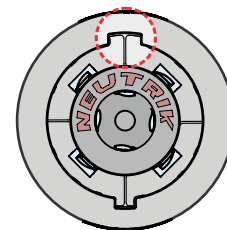
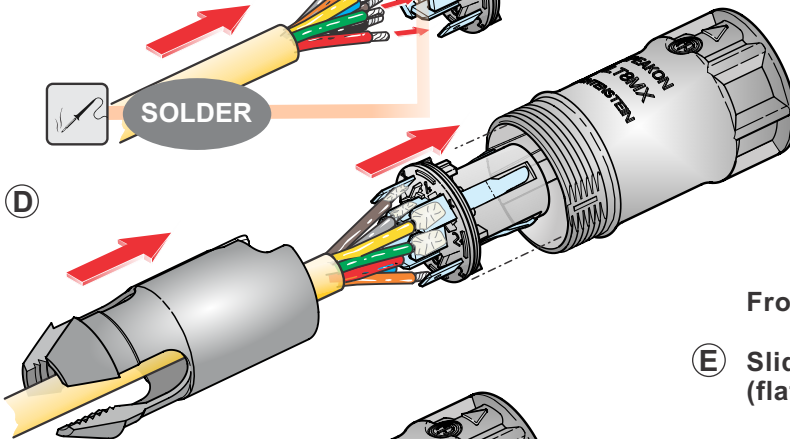

Front view:

E

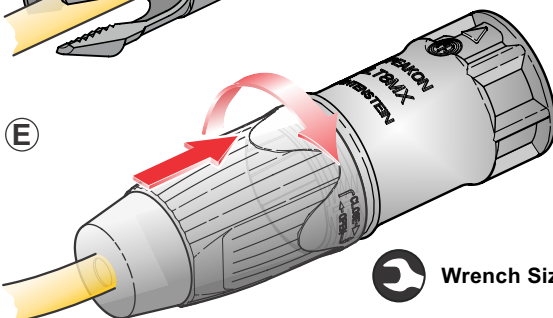

E Slide the bushing up the cable and tighten it (flat wrench SW 27 mm).

Wrench Size = 27



Find more details of speakCON on www.neutrik.com.

Neutrik AG LI T: +423 / 237 24 24 F: +423 / 232 53 93
Neutrik USA Inc. USA T: +1 704 / 972 3050 F: +1 704 / 438 9202
Neutrik (UK) Ltd. UK T: +44 1983 / 811 441 F: +44 1983 / 811 439
Neutrik Vertriebs GmbH DE/NL/AT/DK T: +49 8131 / 280 890 F: +49 8131 / 280 830

Neutrik France FR T: +33 1 / 4131 6750 F: +33 1 / 4131 0511
Neutrik Tokyo Ltd. JP T: +81 3 / 3663 4733 F: +81 3 / 3663 4796
Neutrik Hong Kong Ltd. HK T: +852 / 2687 6055 F: +852 / 2687 6052

Draft. Nr.: BDA 616 V2 | Update: 2021-07-06 | Data subject to change without prior notice. © 2021 NEUTRIK®. NEUTRIK® are registered trademark of Neutrik AG. ALL RIGHTS RESERVED.

www.neutrik.com

NEUTRIK